

# Accepted Manuscript

Effect of aggregate size on bond behaviour between basalt fibre reinforced polymer sheets and concrete

Cheng Yuan, Wensu Chen, Thong M. Pham, Hong Hao



PII: S1359-8368(18)32080-8

DOI: [10.1016/j.compositesb.2018.09.089](https://doi.org/10.1016/j.compositesb.2018.09.089)

Reference: JCOMB 6059

To appear in: *Composites Part B*

Received Date: 3 July 2018

Revised Date: 14 August 2018

Accepted Date: 24 September 2018

Please cite this article as: Yuan C, Chen W, Pham TM, Hao H, Effect of aggregate size on bond behaviour between basalt fibre reinforced polymer sheets and concrete, *Composites Part B* (2018), doi: <https://doi.org/10.1016/j.compositesb.2018.09.089>.

This is a PDF file of an unedited manuscript that has been accepted for publication. As a service to our customers we are providing this early version of the manuscript. The manuscript will undergo copyediting, typesetting, and review of the resulting proof before it is published in its final form. Please note that during the production process errors may be discovered which could affect the content, and all legal disclaimers that apply to the journal pertain.

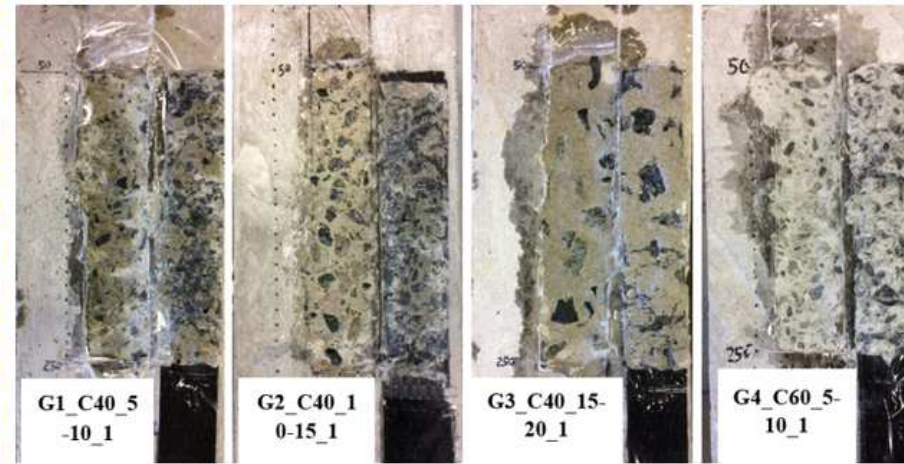
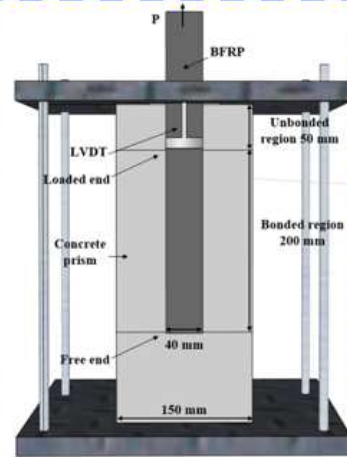
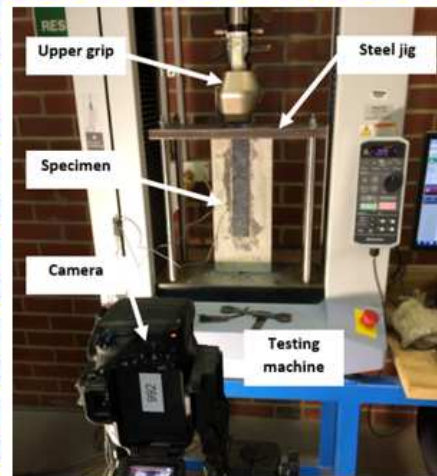

Testing setup

Specimens (Different aggregate sizes)

## Testing results

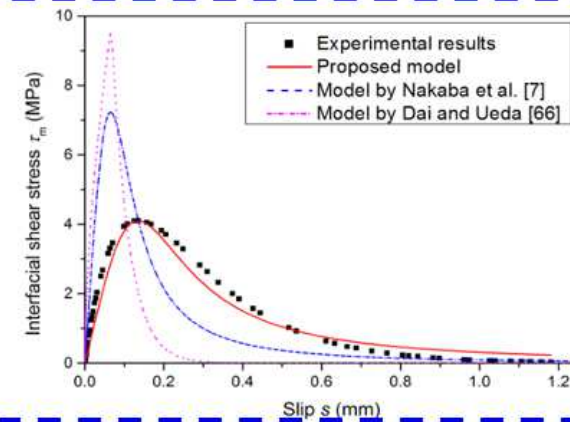
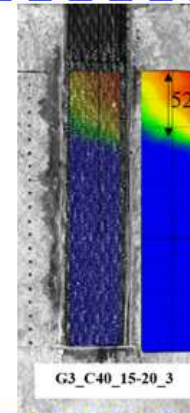
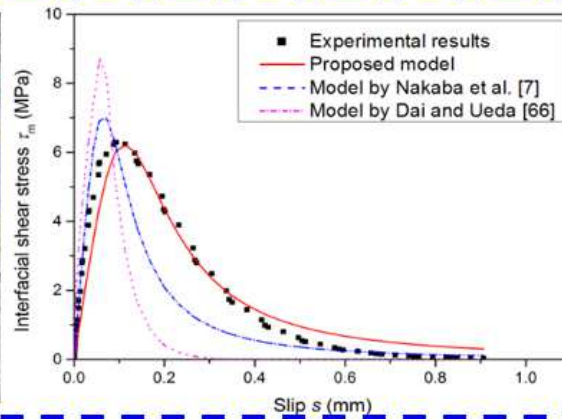
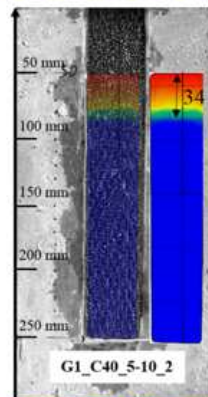

Download English Version:

<https://daneshyari.com/en/article/11020729>

Download Persian Version:

<https://daneshyari.com/article/11020729>

[Daneshyari.com](https://daneshyari.com)