



# Investigation of the pulse energy noise dynamics of IBR-2M using cluster analysis



Yu.N. Pepelyshev<sup>a,\*</sup>, Ts. Tsogtsaikhan<sup>a,b</sup>

<sup>a</sup>Joint Institute for Nuclear Research, 141980 Dubna, Moscow region, Russia

<sup>b</sup>Institute of Physics and Technology, MAS, Mongolia

## ARTICLE INFO

### Article history:

Received 4 August 2014

Received in revised form 16 March 2015

Accepted 2 April 2015

Available online 24 April 2015

### Keywords:

IBR-2M

Pulse energy

Cluster analysis

Power spectrum

## ABSTRACT

In this work we present the results of a study on pulse energy noise dynamics of the IBR-2M; the study employs statistical methods of time series (pulse energy) processing and hierarchical cluster analysis. It is shown that the power spectrum changes of the pulse energy fluctuations per cycle (~11 days) has a transition region duration of ~3 days that takes place after the reactor has reached the nominal power of 2 MW. The power noise is subsequently divided into four stable clusters, with three of which describe the noise transition region. The fourth cluster constitutes a stable structure that does not depend on noise level (amplitude of the power spectrum) or on reactor operation time. The noise transition region is formed by the vibration of the moving reflectors once the reactor has been reached.

© 2015 Elsevier Ltd. All rights reserved.

## 1. Introduction

The key feature of the IBR-2M reactor, as compared to the steady-state reactor, is its high sensitivity to external reactivity perturbations; these perturbations can be up to 40 times higher than those of steady-state reactors using uranium fuel. The pulse energy noise of the IBR-2M reactor – which is caused by the operation of various technological systems, including the reactor core cooling system and the moving reflectors, directly affects the safety as well as the reliability of reactor operation. Owing to the high sensitivity of the reactor to reactivity perturbations, the total pulse energy noise may reach  $\pm 22\%$  in the stabilization mode. The pulse energy noise constitutes one of destabilizing factors of the IBR-2M reactor in that the degradation processes which occur in the core and its vicinity during the operation of the reactor cause a change in the level as well as the structure of the noise. During this mode, the investigation and analysis of the reactor noise variation dynamics is most important for ensuring the safety as well as the reliable operation of the reactor. To this end, the dynamics of the pulse energy noise at the IBR-2M has been investigated using cluster analysis. The hierarchical cluster algorithm is used here as it is more flexible than other methods, thus allowing (a) a detailed study of the structure and differences in pulse energy values, and (b) the selection of the optimal number of clusters. In this piece of research, the results of this analysis are presented, based on

statistical methods of time series processing and hierarchical cluster analysis.

During the 1980's and 90's, pattern recognition methodologies and, in particular, cluster analysis were used widely for the study of the IBR-2 and its condition diagnostics (Gonzalez et al., 1974; Pepelyshev and Dzwiniel, 1990a,b, 1991, 1992, 1994; Pepelyshev et al., 1994). These methods permitted the investigation of very fine and weak reactivity perturbations that could not be observed and investigated with any other method. With advent of powerful computation systems and cluster analysis methods, the application of the aforementioned methods to the upgraded IBR-2M reactor is again of major importance.

## 2. Goal of the work and data processing procedure

The goal of this work is to investigate the dynamics of the pulse energy noise at the IBR-2M during a reactor cycle. The reactor cycle can be described as: operation for two weeks at a power of 2 MW; power drop to almost zero, and an interruption in operation for a week; periodical repetition of this cycle, with the regime chosen in such a manner as to meet the needs of the experiment (neutron beams).

### 2.1. Brief description of the IBR-2M reactor

The IBR-2M reactor is located in Dubna (Moscow region, Russia), and operates with a design power of 2 MW. The IBR-2M core capacity is 69 fuel elements, which are sleeve-like PuO<sub>2</sub>

\* Corresponding author at. Institute of Physics and Technology, MAS, Mongolia.  
Fax: +7 (09621) 6 51 19.

E-mail address: [pepel@nf.jinr.ru](mailto:pepel@nf.jinr.ru) (Y.N. Pepelyshev).

pellets. The coolant is liquid sodium, pumped through the emergency protection blocks by two induction pumps. There are two aligned blades rotating with different speeds past one of the core faces. They are the main movable reflector (MMR) and the auxiliary movable reflector (AMR) of the reactivity modulator. The MMR rotor is a three-tooth blade with a counterbalance, and the AMR rotor is a two-tooth blade. The reactivity level is adjusted by the control and protection system (CPS) elements, which are movable tungsten blocks in an array of fixed steel reflectors. The arrangement of the CPS elements with respect to the IBR-2M core is shown in Fig. 1.

The IBR-2M is a periodic-pulse fast reactor, with periodically repeated power pulses. The key feature of the IBR-2 reactor is the presence of a mechanical reactivity moderator – a moving reflector that allows for a cyclic process of deep change of reactivity. The IBR-2 reactor can be transferred with period of 0.2 s from a deeply subcritical ( $k_{ef} \approx 0,97$ ) state into a supercritical state on prompt neutrons in less than 1 ms. As a result, the reactor generates powerful neutron pulses with a period of 200 ms. In the intervals between pulses (i.e., when there are neither MMR nor AMR in front of the core), the reactor (background) power is approximately four orders of magnitude lower than the power pulse amplitude. Owing to that principle of the pulsing reactivity formation, almost the total release of energy in the reactor takes place during power pulses (93%), with the fraction of pauses being as low as 7% of the total energy.

Since, as already mentioned, the IBR-2M sensitivity to reactivity perturbations is high, the pulse energy has a considerable spread. Sources of random reactivity perturbations include the moving reflectors, vibrations of fuel elements in the turbulent flow of sodium, as well as vibrations induced by the operation of various technological systems. Reactivity noise is one of the destabilizing factors when controlling a reactor. From a safety point of view, the reactivity noise can be divided into two large groups: (a)-high-frequency noise (over  $\sim 0.03$  Hz) that is due to the power feedback and power stabilization system; and (b) low-frequency noise (below the defined frequency). While the reactivity

perturbations from (a) cause pulse energy fluctuations, those from (b) lead to fluctuations in the automatic regulator, which is a high fluctuation in reactivity that can go beyond the stabilization zone.

Pulse energy amplitudes were investigated via repeated measurements of three independent detectors arranged around the core. The current integral corresponding to the power pulse was measured for one of these detectors, showing a detector signal proportional to the pulse energy. Note that, in the power mode of operation (i.e., at the equilibrium pulse criticality), the pulse amplitude and energy are equivalent; the relationship between them can change only if the rotation phase of the main and auxiliary movable reflectors changes for some reason. Hence, the current pulse integral was measured for verifying the main measurements. Each successive power pulse was measured in one of the typical reactor cycles in 2013 with the sodium flow through the core  $100 \text{ m}^3/\text{h}$ . The measurements were carried out for 10.5 days, beginning with the moment when the reactor reached the power of 2 MW and ending with the power drop at the conclusion of the cycle. The recorded time series, that included  $\sim 10^7$  successive pulse energy values, was processed using statistical and cluster analysis procedures. The main element of the statistical analysis was the spread of values, and the object of the cluster analysis was the power spectrum of pulse energy fluctuations. The basic analysis procedures for the measured data are presented below.

## 2.2. Power spectrum of pulse energy fluctuations and pulse energy spread

The total time series (pulse energy)  $X(t)$  recorded within the entire reactor cycle was divided into successive time series  $X_i$  with a length of 8192 (or  $\sim 28$  min). For each time series  $X_i$  a finite Discrete Fourier transform was calculated via the periodogram method. The power spectrum of the reactor pulse energy fluctuations  $S_X^{(i)}(f)$  was determined as

$$|S_X^{(i)}(f)|^2 = F[X_i(t)]^2$$

where  $F$  is the Fourier transform operator. The following parameters of the spread of elements entering into the time series  $X_i$  were investigated:  $\sigma_{f_j}^2$ , dispersion of fluctuations at the average frequency  $f_j$ ;  $\sigma_f^2$ , total dispersion calculated from the spectrum;  $\sigma_t/\bar{Q}$ , relative standard variation ( $\bar{Q}$  is the average pulse energy);  $\sigma_t$ , standard pulse energy deviation calculated in the time domain; and the relative partial root-mean-square deviation

$$\eta_j = \left( \sqrt{\frac{\sigma_{f_j}^2}{\sigma_f^2}} \right) \cdot \frac{\sigma_t}{\bar{Q}} \cdot 100\%$$

## 2.3. Cluster analysis

In the present case, the objective of the cluster analysis was to classify a great amount of IBR-2M noise state data. Various cluster analysis methods (both hierarchical and non-hierarchical) were used. Hierarchical cluster analysis, which is the most flexible of the existing cluster analysis methods, allows the structure of the dissimilarities between objects (between the points) to be investigated, and the optimum number of clusters to be chosen. The non-hierarchical algorithms have been used in addition to the hierarchical ones due to their built-in heuristic data analysis procedures, as for example – in the ISODATA algorithm (Gonzalez et al., 1974), which produced a more significant (large) number of clusters. Each successive power spectrum of the pulse energy fluctuations (hereinafter referred to as the spectrum) reflecting the reactor noise state in the time interval of  $\sim 28$  min (or 8192

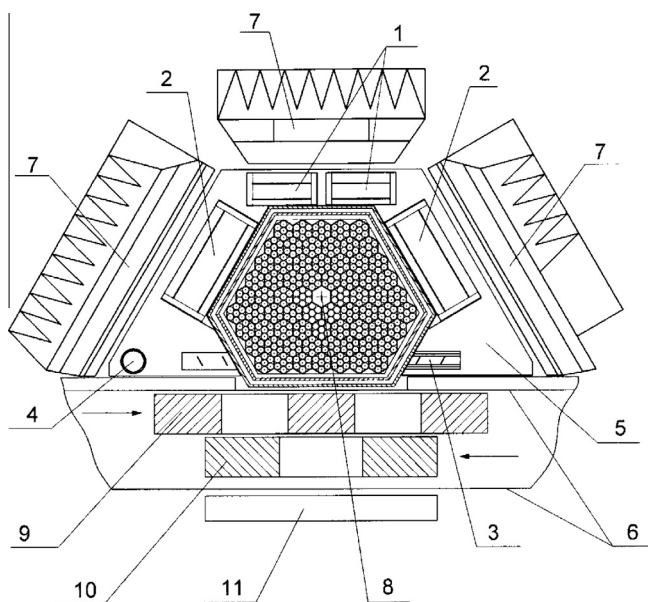

**Fig. 1.** Cross-sectional view of the IBR-2M core: (1) emergency protection blocks, (2) compensation block, (3) intermediate control block, (4) automatic regulator, (5) stationary reflector, (6) movable reflector case, (7) grooved water moderators, (8) external neutron source, (9) main movable reflector (MMR), (10) auxiliary movable reflector (AMR), (11) flat water moderator.

Download English Version:

<https://daneshyari.com/en/article/6767071>

Download Persian Version:

<https://daneshyari.com/article/6767071>

[Daneshyari.com](https://daneshyari.com)